

Product Data Sheet 4114N/2H6AU

ebmpapst

The engineer's choice



4114N/2H6AU

INDEX

1	General	3
2	Mechanics	3
2.1	General	3
2.2	Connections	3
3	Operating Data	5
3.1	Electrical Interface - Input	5
3.2	Electrical Operating Data	6
3.3	Electrical Interface - Output	7
3.4	Electrical Features	7
3.5	Aerodynamics	10
3.6	Sound Data	11
4	Environment	11
4.1	General	11
4.2	Climatic Requirements	11
5	Safety	12
5.1	Electrical Safety	12
5.2	Approval Tests	12
6	Reliability	12
6.1	General	12



1 General

Fan type	Fan	
Rotating direction looking at rotor	Clockwise	
Airflow direction	Air intake over struts	
Bearing system	Stainless steel bearing	
Mounting position - shaft	Any	

2 Mechanics**2.1 General**

Width	119,0 mm	
Height	119,0 mm	
Depth	38,0 mm	
Mass	0,390 kg	
Housing material	Metal	
Impeller material	Plastic	
Max. torque when mounted across both mounting flanges Screw size	Wire outlet corner: 420 Ncm Remaining corners: 600 Ncm ISO 4762 - M4 degreased, without an additional brace and without washer	

2.2 Connections

Electrical connection	Wires	
Lead wire length	L = 310 mm	
Tolerance	+ - 10,0 mm	

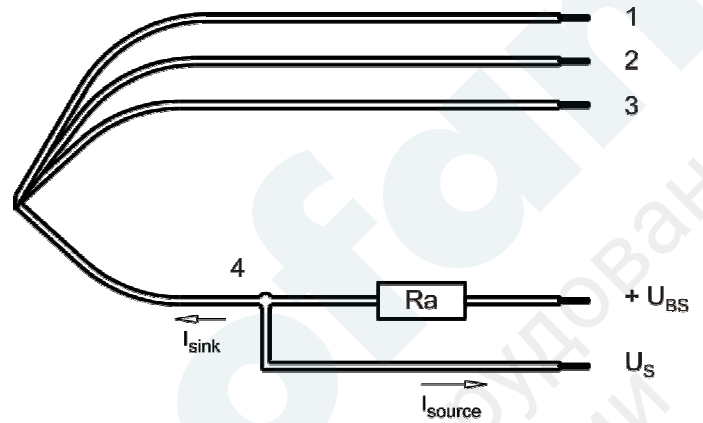

Wire	Color	Operation	Wire size	Insulation diameter
1	red	+ UB	AWG 22	1,7 mm
2	blue	- GND	AWG 22	1,7 mm
3	violet	CONTR	AWG 22	1,7 mm
4	white	Tacho	AWG 22	1,7 mm

The auxiliaries shown on the schematic diagram (which are required for the intended use) are not part of our delivery.

3 Operating Data

3.1 Electrical Interface - Input

Control input	Analog
---------------	--------

Features

Input voltage range	0 V - 10 V
---------------------	------------

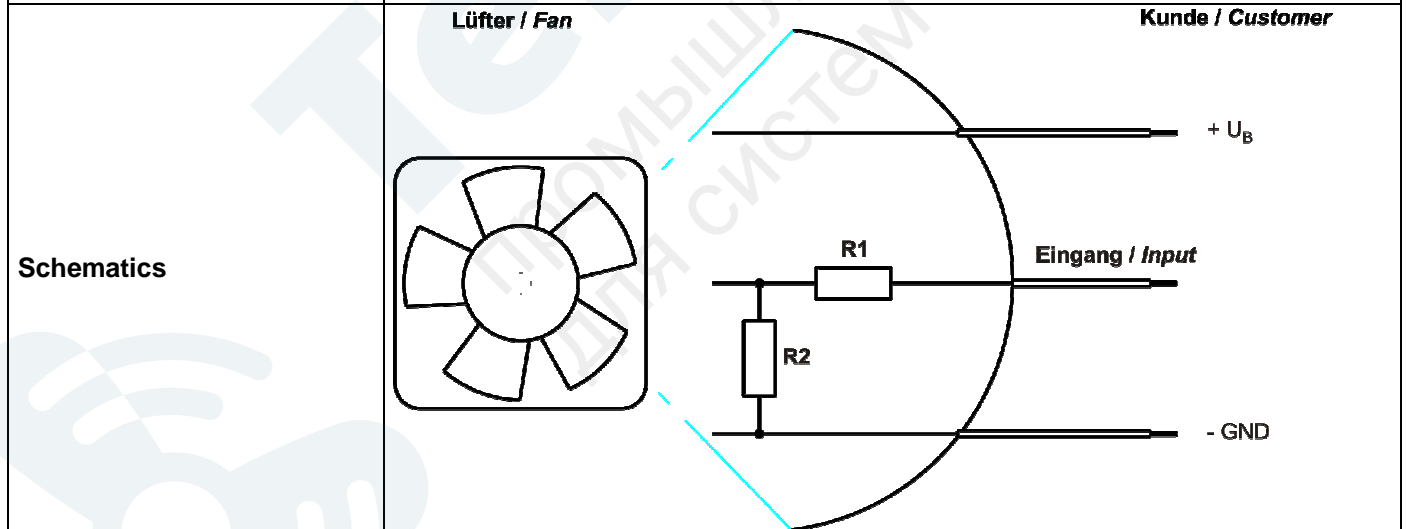
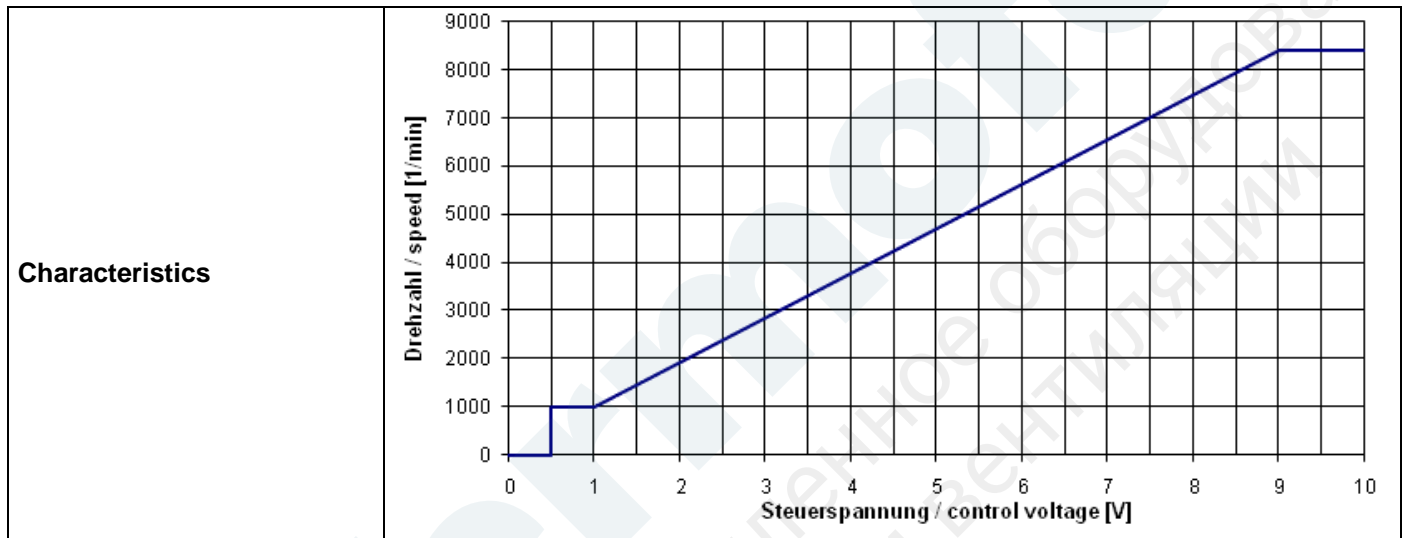

Both input resistors: 100 kOhm

3.2 Electrical Operating Data

Measurement conditions: Normal air density = 1,2 kg/m³; Temperature 23°C +/- 3°C; Motor axis horizontal; warm-up time before measuring 5 minutes (unless otherwise specified). In the intake and outlet area should not be any solid obstruction within 0,5 m.

$\Delta p = 0$: corresp. to free air flow (see chapter aerodynamics)

I: corresp. to arithm. mean current value

Name	Condition
U Contr. 0001	U Contr.: 9,5 V

Note to inrush current @ U nom:

The internal electrolytic capacitor 390uF / 35V has no resistor or inrush current limitation, essentially the type and length of the connecting cable is limiting the Inrush current.

Features	Condition	Symbol	Values		
Voltage range		U	16 V		30 V
Nominal voltage		U_N		24 V	
Power consumption	$\Delta p = 0$	P	48 W	65 W	67 W
Tolerance	U Contr. 0010		+/- 15 %	+/- 10 %	+/- 10 %
Current consumption	$\Delta p = 0$	I	3.070 mA	2.700 mA	2.250 mA
Tolerance	U Contr. 0010		+/- 15 %	+/- 10 %	+/- 10 %
Speed	$\Delta p = 0$	n	7.600 1/min	8.400 1/min	8.400 1/min
Tolerance	U Contr. 0010		+/- 10 %	+/- 5 %	+/- 5 %

3.3 Electrical Interface - Output

Tacho type	/2 (open collector)
------------	---------------------

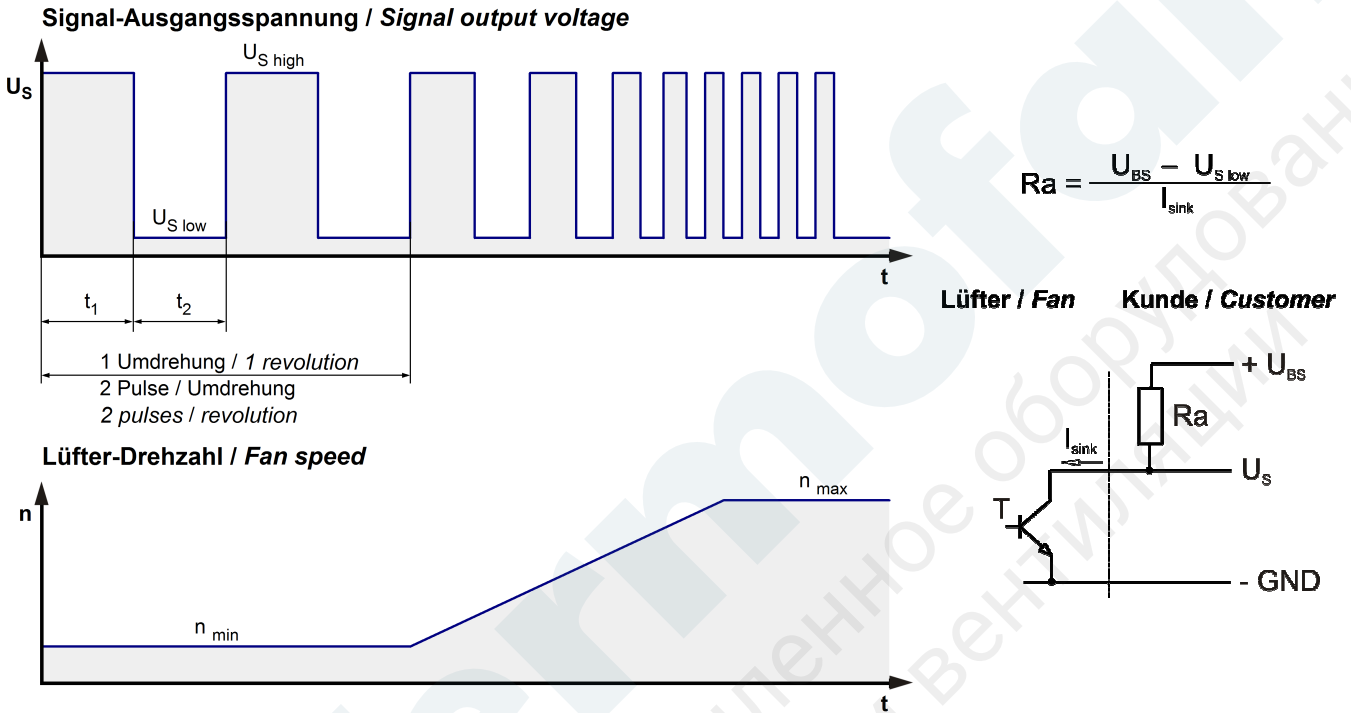

Features	Note	Values
Tacho operating voltage	U_{BS}	$\leq 30\text{ V}$
Tacho signal Low	$U_{S\ low}$	$\leq 0,4\text{ V}$
Tacho signal High	$U_{S\ high}$	$\leq 30\text{ V}$
Maximum sink current	I_{sink}	$\leq 10\text{ mA}$
External resistor	External resistor R_a from U_{BS} to U_S required. All voltages measured to GND.	
Tacho frequency	$(2 \times n) / 60$	
Tacho isolated from motor	No	
Slew rate		$\Rightarrow 0,5\text{ V/us}$

n = revolutions per minute (1/min)

3.4 Electrical Features

Electronic function	Speed-Controlled	
Reversed polarity protection	P-CH FET	
Max. residual current at U_N	$I_F \leq 10\text{ mA}$	
Locked rotor protection	Auto restart	
Locked rotor current at U_N	I_{block} approx. 2.400 mA	
Clock signal at locked rotor	t_3 / t_4 typical: 0,5 s / 5,0 s	

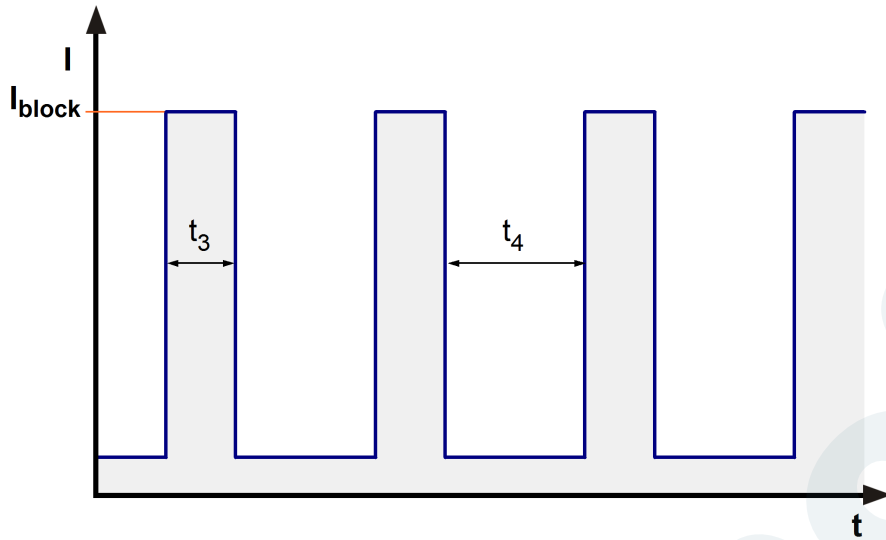

The locked rotor current is denoted as peak-current at nominal voltage.

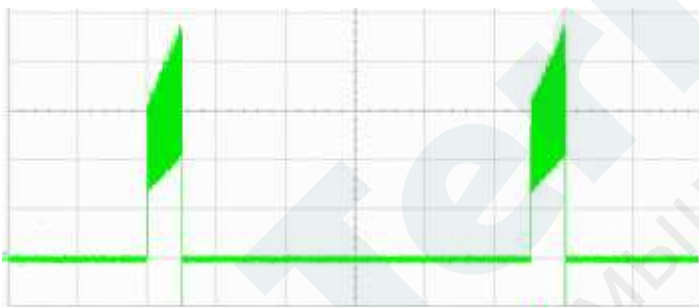

Locked rotor current @ 24 V ($I = 500\text{mA/div}$; $t = 1\text{s/div}$)

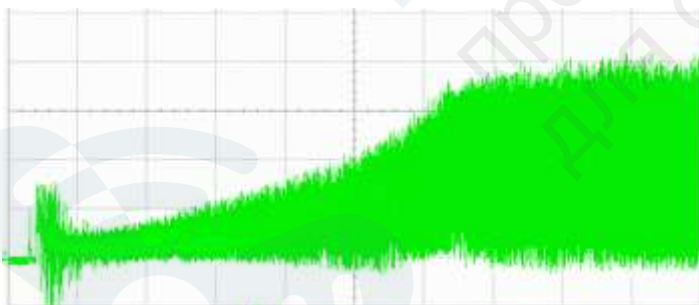

Start-up current @ 24 V ($I = 1\text{A/div}$; $t = 1\text{s/div}$)

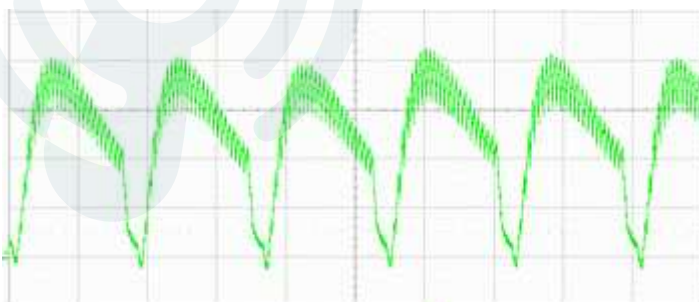

Running current @ 24 V ($I = 1\text{A/div}$; $t = 1\text{ms/div}$)

Internal Fuse:

Littelfuse NANO2(R) FUSE; Very fast acting 451 Series; 7 A (Art.-Nr.: 0451007.MRL)

Termofan
Промышленное оборудование
для систем вентиляции



3.5 Aerodynamics

Measurement conditions:

Measured with a double chamber intake rig acc. to DIN EN ISO 5801.

Normal air density = 1,2 kg/m³; Temperature 23°C +/- 3°C;

In the intake and outlet area should not be any solid obstruction within 0,5 m. Motor shaft horizontal.

The information is only valid under the specified test conditions and may be changed by the installation conditions. If there are deviations from the standard test conditions, the characteristic values must be checked under the installed conditions.

a.) Operation condition:

8.400 1/min at free air flow	U Contr. 9,5 V		
Max. free-air flow ($\Delta p = 0 / \dot{V} = \text{max.}$)		425 m ³ /h	
Max. static pressure ($\Delta p = \text{max.} / \dot{V} = 0$)		860 Pa	

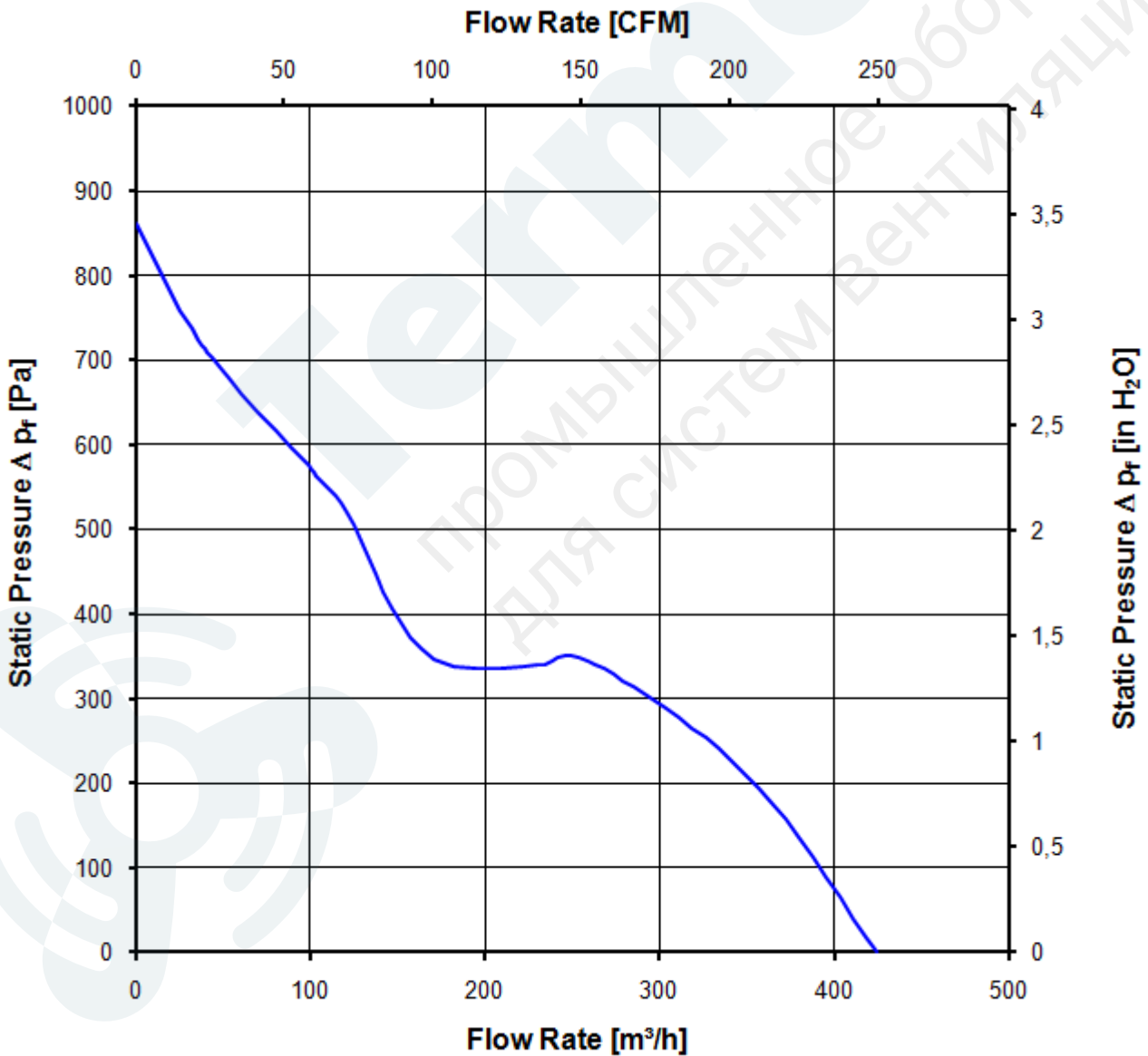

3.6 Sound Data

Measurement conditions: Sound pressure level: 1 meter distance between microphone and the air intake.

Measured in a semianchoic chamber with a background noise level of $L_p(A) < 5 \text{ dB(A)}$
 For further measurement conditions see chapter aerodynamics.

a.) Operation condition:

8.400 1/min at free air flow	U Contr. 9,5 V		
------------------------------	----------------	--	--

4 Environment

4.1 General

Min. permitted ambient temperature TU min.	-20 °C	
Max. permitted ambient temperature TU max.	65 °C	
Min. permitted storage temperature TL min.	-40 °C	
Max. permitted storage temperature TL max.	80 °C	

4.2 Climatic Requirements

IP-protection type (certified)	IP 68 (for fan only, not for connector if applicable) **)	
Humidity requirements	humid temperature, cyclic; according to DIN EN 60068-2-38, 10 cycle and condensation water check; according to DIN EN ISO 6270-2, 14 days	
Salt fog requirements	salt fog, cyclic, in operation; according to DIN EN 60068-2-52, 3 cycle	

Permitted application area:

The product is for the use in open and unsheltered areas. Direct exposure to water as well as saline ambient conditions are allowed provided that this does not prevent the normal operation.

Pollution degree 3 (according DIN EN 60664-1)

It occurs conductive pollution or dry non-conductive pollution which becomes conductive due to condensation.

***) The specification of the IP protection refers to the conditions mentioned in certification of the fan. The above mentioned short description of the protection scope is not final. For detailed information of the respective protection scope and definitions, see certification as well as DIN EN 60529 (protection by housings) and ISO 20653 (for vehicles) with the letter K.

Short description of the IP-protection type:

Solid particle Protection: Dust tight.

Protection against deliberate contact: Protected against contact to hazardous parts with a wire.

Protection against water: The fan test according to IP68 (Based on IEC 60529), is conducted in non-operating mode. The fan is tested by a complete immersion in water for a period of 2h at a water-level of 1,2m. Electrical connections are not immersed since they are customer specific.

Please require severity levels and specification parameters from the responsible development departments.

5 Safety

5.1 Electrical Safety

Dielectric strength DIN EN 60950 (VDE 0805) and DIN EN 60335 (VDE 0700) A.) Type test Measuring conditions: After 48h of storage at 95% R.H. and 25°C. No arcing or breakdown is allowed! All connections together to ground. B.) Routine test Measuring conditions: At indoor climate. No arcing or breakdown is allowed! All connections together to ground.	500 VAC / 1 Min. 850 VDC / 1 Sec.	
Isolation resistance Measuring conditions: After 48h of storage at 95% R.H. and 25°C measured with U=500 VDC for 1 min.	RI > 10 MOhm	
Clearance / creepage distance	1,0 mm / 1,2 mm	
Protection class	III	

5.2 Approval Tests

CE	EC Declaration of Conformity	Yes
EAC	Eurasian Conformity	Yes
UL	Underwriters Laboratories	Yes / UL507, Electric Fans
VDE	Association for Electrical, Electronic and Information Technologies	Yes / Approval acc. to EN 60950 (VDE 0805) - Information technology equipment
CSA	Canadian Standards Association	Yes / C22.2 No. 113 Fans and Ventilators
CCC	China Compulsory Certification	Not applicable

The approval tests are observed to:

U approval max.: 30,0 V @ TU approval max.: 65,0 °C

6 Reliability

6.1 General

Life expectancy L10 at TU = 40 °C	60.000 h	
Life expectancy L10 at TU max.	32.500 h	
Life expectancy L10 acc. to IPC 9591 at TU = 40 °C	102.500 h	

